

# Synthesized Function Generator

SFG-2000/SFG-2100 Series

---

## USER MANUAL

GW INSTRUMENT PART NO. 82FG-21200MD

This manual contains proprietary information, which is protected by copyrights. All rights are reserved. No part of this manual may be photocopied, reproduced or translated to another language without prior written consent of Good Will company.

The information in this manual was correct at the time of printing. However, Good Will continues to improve products and reserves the rights to change specification, equipment, and maintenance procedures at any time without notice.



ISO-9001 CERTIFIED MANUFACTURER

**GW INSTRUMENT**

Good Will Instrument Co., Ltd.

No. 7-1, Jhongsing Rd., Tucheng City, Taipei County 236, Taiwan.

# Table of Contents

**SAFETY INSTRUCTIONS** ..... 5

Safety Symbols..... 5

Safety Guidelines..... 6

**GETTING STARTED** ..... 9

Technical background .....10

Lineup/Features.....12

Front Panel .....13

Rear Panel.....19

Set Up.....20

Operation Shortcuts .....22

Default Setting Contents.....24

**SINE/SQUARE/TRIANGLE WAVE** .....25

Select the waveform.....26

Set the Frequency.....26

Set the Duty Cycle (Square Waveform) .....28

Set Amplitude.....29

Set Offset.....30

**TTL CMOS OUTPUT** .....31

Select the waveform.....32

Set the Frequency.....32

Set the Duty Cycle.....33

Set Amplitude.....34

**SWEEP**.....35

**AMPLITUDE MODULATION** .....37

**FREQUENCY MODULATION**..... 38

**COUNTER INPUT** ..... 40

**STORE/RECALL SETTING**..... 42

**APPLICATION EXAMPLES** ..... 44

Reference Signal for PLL System ..... 44

Trouble-Shooting Signal Source..... 44

Transistor DC Bias Characteristics Test ..... 45

Amplifier Over-Load Characteristic Test ..... 46

Amplifier Transient Characteristics Test ..... 46

Logic Circuit Test..... 48

Impedance Matching Network Test ..... 48

Speaker Driver Test..... 49

Sweep for Speaker Test..... 50

**FAQ** ..... 51

**APPENDIX**..... 52

Error Messages ..... 52

Specification..... 53

Declaration of Conformity ..... 55

**INDEX** ..... 56

# S SAFETY INSTRUCTIONS

This chapter contains important safety instructions that you must follow when operating SFG-2000 series and when keeping it in storage. Read the following before any operation to insure your safety and to keep the best condition for SFG-2000 series.



## Safety Symbols

These safety symbols may appear in this manual or on SFG-2000 series.



**WARNING**

Warning: Identifies conditions or practices that could result in injury or loss of life.



**CAUTION**

Caution: Identifies conditions or practices that could result in damage to SFG-2000 series or to other properties.



Attention Refer to the Manual



Earth (ground) Terminal

## Safety Guidelines

### General Guideline



**CAUTION**

- Do not place any heavy object on SFG-2000 series.
- Avoid severe impacts or rough handling that leads to damaging SFG-2000 series.
- Do not discharge static electricity to SFG-2000 series.
- Use only mating connectors, not bare wires, for the terminals.
- Do not block or obstruct cooling vent opening.
- Do not perform measurements at power source and building installation site (Note below).
- Do not disassemble SFG-2000 series unless you are qualified as service personnel.

(Note) EN 61010-1:2001 specifies the measurement categories and their requirements as follows. SFG-2000 series falls under category II.

- Measurement category IV is for measurement performed at the source of low-voltage installation.
- Measurement category III is for measurement performed in the building installation.
- Measurement category II is for measurement performed on the circuits directly connected to the low voltage installation.

### Power Supply



**WARNING**

- Input voltage: 115/230V AC +10%, -15%, 50/60Hz
- The power supply voltage should not fluctuate more than 10%.
- Connect the protective grounding conductor of the power cord to earth ground, to avoid electrical shock.

### Fuse



**WARNING**

- Fuse type: T0.125A/ 250V
- Only service personnel are allowed to access internal fuse holders.
- Replace the fuse with the specified type and rating only, for continued fire protection.
- Disconnect the power cord before fuse replacement.
- Make sure the cause of the fuse blowout is fixed before fuse replacement.

Cleaning SFG-2000 series	<ul style="list-style-type: none"> <li>• Disconnect the power cord before cleaning.</li> <li>• Use a soft cloth dampened in a solution of mild detergent and water. Do not spray any liquid into SFG-2000 series.</li> <li>• Do not use chemicals or cleaners containing harsh materials such as benzene, toluene, xylene, and acetone.</li> </ul>
Operation Environment	<ul style="list-style-type: none"> <li>• Location: Indoor, no direct sunlight, dust free, almost non-conductive pollution (Note below)</li> <li>• Relative Humidity: &lt; 80%</li> <li>• Altitude: &lt; 2000m</li> <li>• Temperature: 0°C to 40°C</li> </ul> <p>(Note) EN 61010-1:2001 specifies the pollution degrees and their requirements as follows. SFG-2000 series falls under degree 2. Pollution refers to “addition of foreign matter, solid, liquid, or gaseous (ionized gases), that may produce a reduction of dielectric strength or surface resistivity”.</p> <ul style="list-style-type: none"> <li>• Pollution degree 1: No pollution or only dry, non-conductive pollution occurs. The pollution has no influence.</li> <li>• Pollution degree 2: Normally only non-conductive pollution occurs. Occasionally, however, a temporary conductivity caused by condensation must be expected.</li> <li>• Pollution degree 3: Conductive pollution occurs, or dry, non-conductive pollution occurs which becomes conductive due to condensation which is expected. In such conditions, equipment is normally protected against exposure to direct sunlight, precipitation, and full wind pressure, but neither temperature nor humidity is controlled.</li> </ul>
Storage Environment	<ul style="list-style-type: none"> <li>• Location: Indoor</li> <li>• Relative Humidity: &lt; 80%</li> <li>• Temperature: -10°C to 70°C</li> </ul>

## Power cord for the United Kingdom

When using SFG-2000 series in the United Kingdom, make sure the power cord meets the following safety instructions.

NOTE: This lead / appliance must only be wired by competent persons



**WARNING: THIS APPLIANCE MUST BE EARTHED**

IMPORTANT: The wires in this lead are coloured in accordance with the following code:

Green/ Yellow: Earth  
 Blue: Neutral  
 Brown: Live (Phase)



As the colours of the wires in main leads may not correspond with the colours marking identified in your plug/appliance, proceed as follows:

The wire which is coloured Green & Yellow must be connected to the Earth terminal marked with the letter E or by the earth symbol  or coloured Green or Green & Yellow. The wire which is coloured Blue must be connected to the terminal which is marked with the letter N or coloured Blue or Black.

The wire which is coloured Brown must be connected to the terminal marked with the letter L or P or coloured Brown or Red.

If in doubt, consult the instructions provided with the equipment or contact the supplier. This cable/appliance should be protected by a suitably rated and approved HBC mains fuse: refer to the rating information on the equipment and/or user instructions for details. As a guide, cable of 0.75mm<sup>2</sup> should be protected by a 3A or 5A fuse. Larger conductors would normally require 13A types, depending on the connection method used.

Any moulded mains connector that requires removal /replacement must be destroyed by removal of any fuse & fuse carrier and disposed of immediately, as a plug with bared wires is hazardous if engaged in live socket. Any re-wiring must be carried out in accordance with the information detailed on this label.

# G ETTING STARTED

This chapter describes SFG-2000 series in a nutshell, including main features and front/rear/display introduction. Follow the Set Up section to properly install and power up SFG-2000 series.



---

<b>SFG-2000 series overview</b>	Technical background .....	10
	Series lineup .....	12
	Main features .....	12
<b>Panel introduction</b>	Front Panel .....	13
	Rear Panel .....	19
<b>Setup</b>	Tilt stand .....	20
	Power up .....	21
	Recall the default setting .....	21
	Functionality check .....	21
<b>Quick reference</b>	Operation Shortcuts .....	22
	Default Setting Contents .....	24

---

## Technical background

---

### Traditional function generators

SFG-2000 series uses the latest Direct Digital Synthesis (DDS) technology to generate stable, high resolution output frequency. The DDS technology solves several problems encountered in traditional function generators, as follows.

### Constant current circuit methodology

This analog function generating method uses a constant current source circuit built with discrete components such as capacitors and resistors. Temperature change inside the generator greatly affects the components characteristics which lead to output frequency change. The results are poor accuracy and stability.

---

### DDS methodology

In DDS, the waveform data is contained in and generated from a memory. A clock controls the counter which points to the data address. The memory output is converted into analog signal by a digital to analog converter (DAC) followed by a low pass filter. The resolution is expressed as  $f_s/2k$  where  $f_s$  is the frequency and  $k$  is the control word, which contains more than 28bits. Because the frequency generation is referred to clock signal, this achieves much higher frequency stability and resolution than the traditional function generators.

---

**Block diagram**

DDS synthesizer consists of Phase accumulator (counter), lookup table data (ROM), Digital-to-analog converter (DAC), and Low-pass filter (LPF).

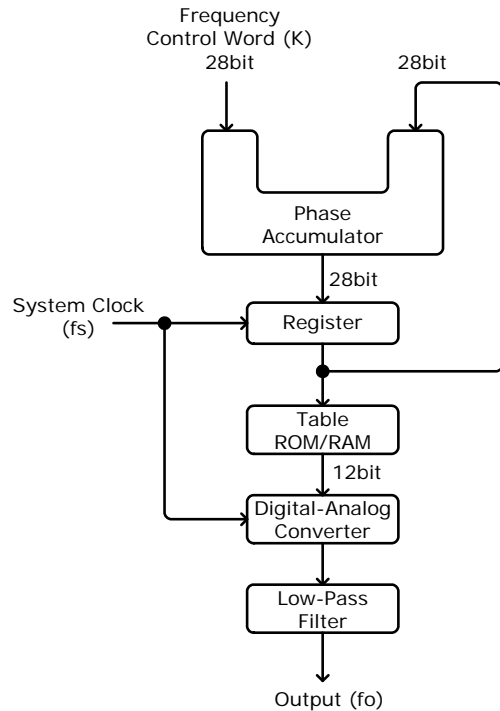

The phase accumulator adds the frequency control word K at every clock cycle  $f_s$ . The accumulator output points to a location in the Table ROM/RAM. The DAC converts the digital data into an analog waveform. The LPF filters out the clock frequency to provide a pure waveform.

## Lineup/Features

### Series lineup

Lineup	Features	Duty cycle	Offset	TTL/CMOS	Sweep	AM/FM	Counter
SFG-2004 (4MHz)		●	●	●	—	—	—
SFG-2007 (7MHz)		●	●	●	—	—	—
SFG-2010 (10MHz)		●	●	●	—	—	—
SFG-2020 (20MHz)		●	●	●	—	—	—
SFG-2104 (4MHz)		●	●	●	●	●	●
SFG-2107 (7MHz)		●	●	●	●	●	●
SFG-2110 (10MHz)		●	●	●	●	●	●
SFG-2120 (20MHz)		●	●	●	●	●	●

### Main features

- Performance**
  - High resolution using DDS and FPGA technology
  - High frequency accuracy: 20ppm
  - Low distortion: -55dBc
  - High resolution 100mHz maintained at full range
- Features**
  - Wide output frequency range: 4, 7, 10, 20MHz
  - Various output waveforms: Sine, Square, and Triangle
  - TTL/CMOS output
  - Variable DC offset control
  - Output overload protection
  - Store/recall: 10 settings
  - Counter up to 150MHz high frequency (SFG-2100 series)
  - AM/FM with internal and external (SFG-2100 series)
  - Sweep mode with LINE and LOG (SFG-2100 series)
- Input/Output Terminals**
  - Frequency output
  - TTL/CMOS output
  - Counter input (SFG-2100 series)
  - External modulation input (SFG-2100 series)

Front Panel

SFG-2100 series front panel

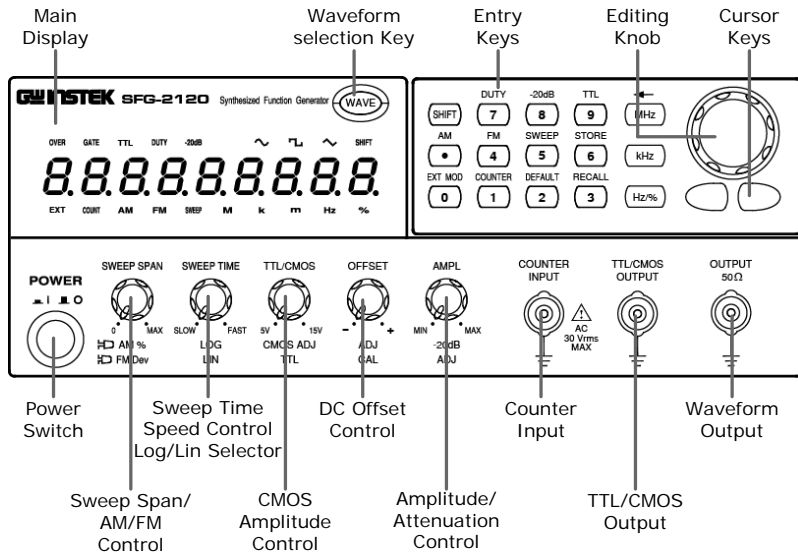

SFG-2000 series front panel

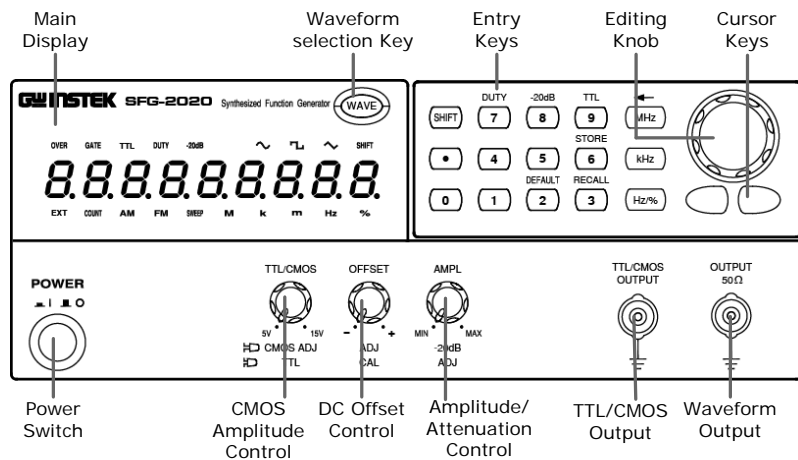

- Main display**  (7 segment) Shows the waveform frequency, counter frequency, and duty cycle.
- OVER** For SFG-2100 series only. In the counter mode, indicates that the leftmost digit (100MHz) is hidden but contains a real number. For counter details, see page40.
- GATE** For SFG-2100 series only. In counter mode, indicates gate selection. For counter details, see page40.
- TTL** Indicates that the TTL or CMOS output is enabled. For TTL/CMOS details, see page31.
- DUTY** For square waveform only. Indicates that the duty cycle is being edited. For square waveform details, see page25.
- 20dB** Indicates that the waveform output is attenuated by -20dB. For attenuation details, see page29.
- SWEEP** For SFG-2100 series only. Indicates that the sweep mode is activated. For sweep details, see page35.
- FM AM** For SFG-2100 series only. Indicates that FM or AM mode is enabled. For modulation details, see page37 (AM) or page38(FM).
- COUNT** For SFG-2100 series only. Indicates that the counter mode is enabled. For counter details, see page40.
- EXT** For SFG-2100 series only. Indicates that the external modulation input is used. For details, see page37 (AM) or page39(FM).

 Indicates the waveform shape: Sine, Square, and Triangle. For details, see page26.

**SHIFT** Indicates that the Shift key is pressed.

**M k m Hz** Indicates the output frequency: MHz, kHz, or Hz.

**%** Indicates the duty cycle unit. For duty cycle details, see page28.

**Waveform selection key**  Selects the waveform shape: sine, square, and triangle. For details, see page26.

**Entry keys** Enters frequency, duty cycle, and various parameters.

 1.2MHz

 37kHz

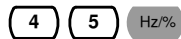
 45% (in duty cycle mode)  
45Hz (in frequency mode)

 Enter duty cycle (page28).

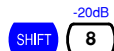
 Attenuate the waveform output by -20dB (page29).

 Enables TTL/CMOS output (page31).

 Deletes previous entry (backspace).

 Selects Amplitude Modulation (page37).

 Selects Frequency Modulation (page38).

 Selects sweep mode (page35).

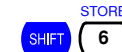
 Stores the parameter setting (page42).

 Recalls the parameter setting (page42).

 Recalls the default parameter setting (page43).

 Switches to counter mode (page40).

 Accepts external modulation signal (page37-AM) or (page38-FM).

**Editing knob**  Increases (right turn) or decreases (left turn) the frequency or duty cycle.

**Cursor keys**  Moves the editing point left or right in case of manual editing.

**Waveform output**  Outputs sine, square, and triangle waveform. BNC terminal, 50Ω output impedance.

**TTL/CMOS output**  Outputs TTL or CMOS output waveform, BNC terminal. For TTL/CMOS mode details, see page31.

**Counter input**  Accepts signals for frequency counting. BNC, AC 30Vrms maximum. For counting mode details, see page40.

 Max AC 30Vrms



**Amplitude/  
Attenuation  
control**

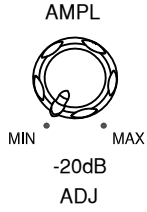

Sets the sine/square/triangle waveform amplitude. Turn left (decrease) or right (increase).

When pulled out, attenuates the sine/square/triangle waveform amplitude by -20dB. The -20dB display turns On.

For details, see page29.

**DC offset  
control**

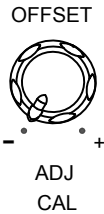

When pulled out, sets the DC offset level for sine/square/triangle waveform. Turn left (decrease) or right (increase). The range is -5V ~ +5V, in 50Ω load.

For details, see page30.

**CMOS  
amplitude  
control**

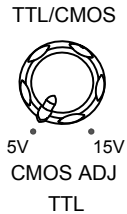

This knob becomes effective when the TTL/CMOS output is enabled (page31).

Selects TTL as output.

When pulled out, selects CMOS as output. Sets the CMOS output level. Turn left (decrease) or right (increase).

**Sweep speed  
control**

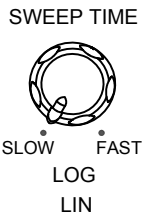

This knob is available in SFG-2100 series only. It becomes effective in sweep time mode.

Sets the sweep speed. Turn left (slow) or right (fast). The range is 1 ~ 30 seconds. For sweep details, see page35.

Selects linear sweep.

When pulled out, selects logarithmic sweep.

**Sweep span  
control**

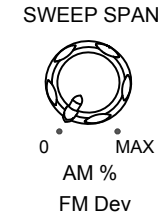

This knob is available in SFG-2100 series only. It becomes effective in sweep mode and AM/FM mode.

**AM/FM  
modulation  
control**

In Sweep mode: Sets the sweep span. Turn left (narrow) or right (wide). The range is 1 ~ 100. For sweep details, see page36.

In AM/FM mode:

Sets the FM deviation (page38). Turn left (decrease) or right (increase). The range is over -50kHz ~ +50kHz, centered at 1MHz.

When pulled out, sets the AM depth (page37). Turn left (shallow) or right (deep). The range is 0 ~ 100%.

**Power switch**



Turns the main power On/Off. For power up sequence, see page20.

## Rear Panel

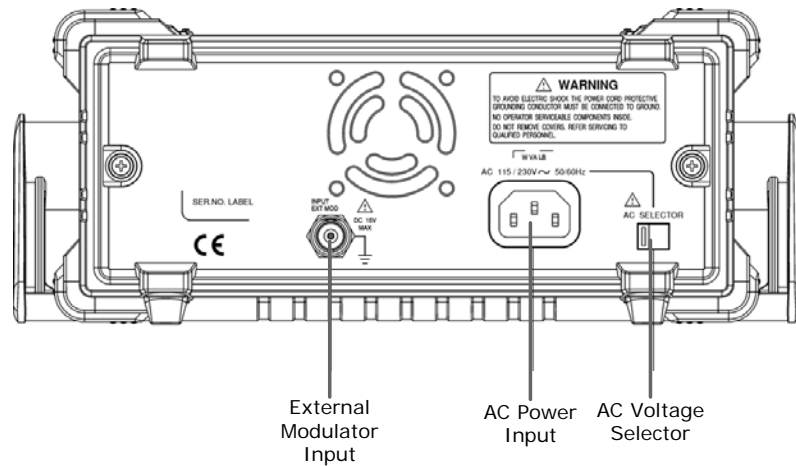

<b>External Modulator Input</b>	Accepts the modulation signal from external device. BNC male connector, 10Vp-p maximum. SFG automatically switches the modulation signal from internal to external. For modulation details, see page37 (AM) or page38(FM).
<b>AC Power Input</b>	Accepts the AC power cord. 115 or 230V, 50/60Hz.
<b>AC Voltage Selector</b>	<p>Selects 115V or 230V for power source.</p> <p>AC 100/110/120V → select 115V.</p> <p>AC 220/230/240V → select 230V.</p> <p> Improper selection might lead to internal fuse blowout.</p>

## Set Up

### Tilt stand

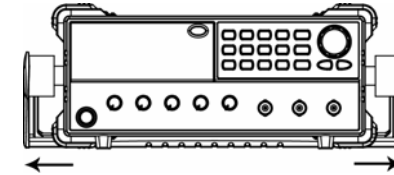

Pull out the handle sideways and rotate it.

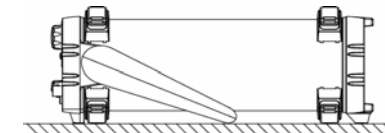

Place SFG horizontally,

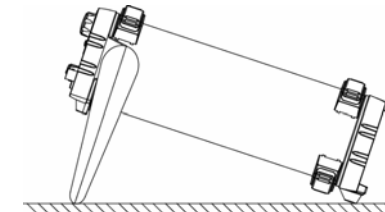

Or tilt stand.

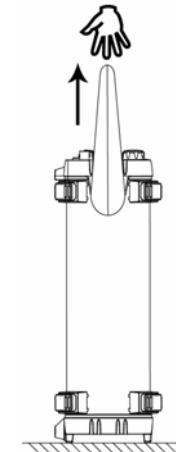

Place the handle vertically for hand carry.

**Power up**



1. Select the AC voltage on the rear panel accordingly.  
AC 100/110/120V → select 115V.  
AC 220/230/240V → select 230V.
2. Connect the power cord.
3. Push and turn On the main power switch on the front panel.
4. The display shows model name and the last setup.  
Example: SFG-2110, 500Hz triangle wave in sweep mode and -20dB attenuation enabled

**AC SELECTOR**



AC 115 / 230V ~ 50/60Hz

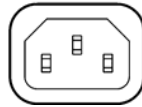

**POWER**



SFG-2110

-20dB  
500.0  
SWEEP Hz

**Recall the default setting**

Press **SHIFT** **2** to recall the default setup. SFG shows the message “done”, and outputs 10kHz sine wave.

done  
10.0000  
k Hz





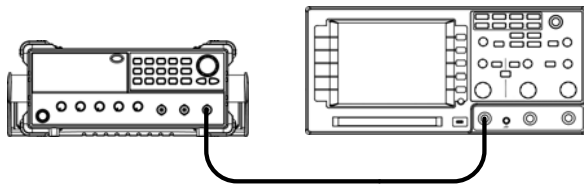







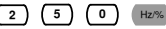
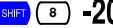



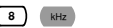

**Functionality check**

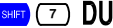



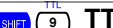
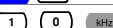
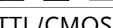

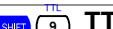
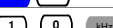
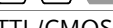





























Connect SFG output to measurement device such as oscilloscope and check the waveform characteristics.











**Operation Shortcuts**



Here are the collections of operation example shortcuts.

<p>Sine wave 250Hz, -20dB amplitude</p> <p>OUTPUT 50Ω</p> 	<ol style="list-style-type: none"> <li>1. Press Wave key and select Sine</li> <li>2. Press 2 + 5 + 0 + Hz/% key</li> <li>3. Press Shift + 8 key (-20dB) ...Or pull Amplitude knob</li> </ol>	   <p>-20dB</p> <p>or AMPL ADJ</p> 
<p>Triangle wave 8kHz, +2V Offset</p> <p>OUTPUT 50Ω</p> 	<ol style="list-style-type: none"> <li>1. Press Wave key and select Triangle</li> <li>2. Press 8 + kHz key</li> <li>3. Pull Offset knob (ADJ) and Rotate</li> </ol>	  <p>OFFSET ADJ</p> 
<p>Square Wave 1MHz, 45% duty</p> <p>OUTPUT 50Ω</p> 	<ol style="list-style-type: none"> <li>1. Press Wave key and select Square</li> <li>2. Press 1 + MHz key</li> <li>3. Press Shift + 7 key (Duty)</li> <li>4. Press 4 + 5 + Hz/% key ...Or Rotate the Scroll knob</li> </ol>	   <p>DUTY</p>  <p>or</p> 
<p>TTL Output 10kHz</p> <p>TTL/CMOS OUTPUT</p> 	<ol style="list-style-type: none"> <li>1. Press Shift + 9 key (TTL)</li> <li>2. Press 1 + 0 + kHz key</li> <li>3. Press TTL/CMOS knob (TTL)</li> </ol>	  <p>TTL</p>  <p>TTL/CMOS (TTL)</p> 
<p>CMOS Out 10kHz, 10Vpp</p> <p>TTL/CMOS OUTPUT</p> 	<ol style="list-style-type: none"> <li>1. Press Shift + 9 key (TTL)</li> <li>2. Press 1 + 0 + kHz key</li> <li>3. Pull TTL/CMOS knob (CMOS) and rotate</li> </ol>	  <p>TTL</p>  <p>TTL/CMOS (CMOS)</p> 

Linear Sweep, 1kHz start, Sine wave 250Hz OUTPUT 50Ω 	1. Press Wave key and select Sine	 
	2. Press 2 + 5 + 0 + Hz/% key	   
	3. Press Shift + 5 key (Sweep)	  <b>SWEEP</b>
	4. Press SWEEP TIME knob (LIN) and rotate	 <b>SWEEP TIME LIN</b>
Log Sweep, 10kHz start, Triangle wave 8kHz OUTPUT 50Ω 	1. Press Wave key and select Triangle	 
	2. Press 8 + kHz key	 
	3. Press Shift + 5 key (Sweep)	  <b>SWEEP</b>
	4. Pull SWEEP TIME knob (LOG) and rotate	 <b>SWEEP TIME LOG</b>
AM, Internal, 50% modulation, sine wave 10kHz OUTPUT 50Ω 	1. Press Wave key and select Sine	 
	2. Press 1 + 0 + kHz key	  
	3. Press Shift + .(dot) key (AM)	  <b>AM</b>
	4. Pull SWEEP SPAN knob (AM %) and rotate	 <b>SWEEP SPAN</b>
FM, External, 50% deviation, sine wave 1MHz OUTPUT 50Ω 	1. Press Wave key and select Sine	 
	2. Press 1 + MHz key	 
	3. Input external modulation signal (EXT sign appears)	 
	4. Press Shift + 4 key (FM)	  <b>FM</b>
	5. Push SWEEP SPAN knob (FM Dev) and rotate	 <b>SWEEP SPAN (FM Dev)</b>

Counter input, sine wave 1MHz COUNTER INPUT 	1. Press Shift + 1 (Counter)	  <b>COUNT</b>
	2. The Gate sign flashes when counted	<b>GATE</b>
Store the setting to memory No.1 COUNTER INPUT 	1. Press Shift + 6 (Store)	  <b>STORE 0</b>
	2. The "Store" sign appears	<b>store 0</b>
	3. Enter the memory number (1 ~ 10)	<b>store 1</b>
	4. The "done" sign appears	<b>done</b>
Recall the setting from memory No.1 COUNTER INPUT 	1. Press Shift + 3 (Recall)	  <b>RECALL 0</b>
	2. The "Recall" sign appears	<b>recall 0</b>
	3. Enter the memory number (1 ~ 10)	<b>recall 1</b>
	4. The "done" sign appears	<b>done</b>

## Default Setting Contents

Recall default settings COUNTER INPUT 	1. Press Shift + 2 (Default)	  <b>DEFAULT 2</b>
	2. Press the shift key, then 2 to recall the default setting. The "done" message appears, followed by display update.	<b>done</b> <b>10.0000</b> kHz Hz
Wave type	Sine wave	
Frequency	10.0000kHz	
TTL/CMOS	Disabled	
-20dB	Disabled	
Modulation	Disabled	
Sweep mode	Disabled	

# SINE/SQUARE/TRIANGLE





## WAVE



<b>Select waveform</b>	Select the waveform.....	26
<b>Set frequency</b>	Enter frequency.....	26
	Edit frequency.....	27
<b>Set duty cycle (for square wave)</b>	Enter duty cycle.....	28
	Edit duty cycle.....	28
<b>Set amplitude</b>	Normal output.....	29
	Attenuate by -20dB .....	29
<b>Set offset</b>	Activate offset.....	30
	Adjust offset .....	30
	Limitation .....	30

## Select the waveform

Sine / Square / Triangle Press **WAVE** key repeatedly. The corresponding icon appears on the display.

-  Sine waveform.
-  Square waveform.
-  Triangle waveform.
- OUTPUT 50Ω**  
 The waveform comes out from the main terminal.  
10Vp-p maximum (50Ω load)  
20Vp-p maximum (no load)

## Set the Frequency

Enter frequency Enter the waveform frequency using the numerical keys.

- 1** **0** **2** MHz 1.2MHz
- 3** **7** kHz 37kHz
- 4** **5** Hz/% 45Hz
- SHIFT** **MHz** Delete a number (backspace)

 Triangle waveform frequency is limited to maximum 1MHz. When the input exceeds it, the following message (Freq-Err2) appears and forces the frequency to 1MHz.

**FREQ-ERR2**

For full error message list, see page52.

Edit frequency



Left cursor key moves the active cursor left.

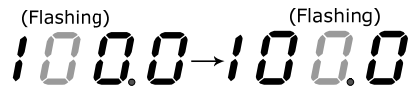

Right cursor key moves the active cursor right.

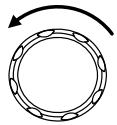
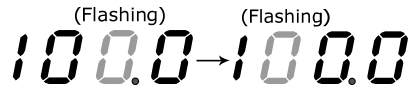

Turn the editing knob left to decrease the frequency.

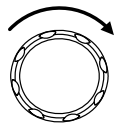
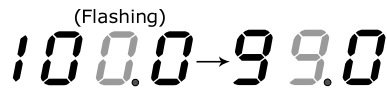

Turn the editing knob right to increase the frequency.

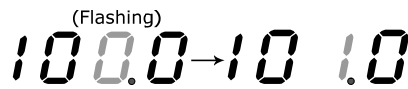

## Set the Duty Cycle (Square Waveform)

The duty cycle setting is not available in sine/triangle waveform.

Enter duty cycle



Press the Shift key, then 7 to enter duty cycle editing mode. The duty sign appears on the display.



The default value is 50%.

The settable range is 20% ~ 80%, 2Hz ~ 1MHz.

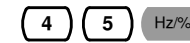

Use numerical keys to enter value.

Example: 45%



Delete a number (backspace)

Edit duty cycle



The editing knob changes the value, and the cursor keys moves the active digit (same as entering frequency).

When inactive for 5 seconds, the display automatically goes back to previous mode (frequency view).

Setting duty cycle (press **SHIFT** **7**) is not available when sine or triangle waveform is activated. The following message appears.

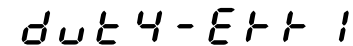

For full error message list, see page 52.

## Set Amplitude

Normal output

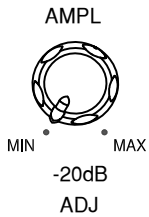

Turn the Amplitude knob right (increase) or left (decrease).  
The range is 10Vpp for 50Ω load.

Attenuate by -20dB

Sine/square/triangle waveform can be attenuated by -20dB, in two ways: -40dB altogether.



**Method1**

Pull out the Amplitude knob. The output amplitude is attenuated by -20dB (no display sign).



**Method2**

Press the shift key, then 8. The output amplitude is attenuated by -20dB. The -20dB sign appears on the display.

## Set Offset

Activate offset

SFG can add or delete offset to the sine/square/triangle waveform, thus changing the waveform vertical position. Use the OFFSET knob.



Pushed: Offset Off



Pulled: Offset On

Adjust offset

OFFSET



Turn the knob right (higher position) or left (lower position).

The range is -5V ~ +5V for 50Ω load.

Limitation



Note that the output amplitude, including the offset, is still limited to:

-5 ~ +5V (50Ω load)

-10 ~ +10V (no load)

Therefore excessive offset leads to peak clip as below.

**Positive peak clip (50Ω)**

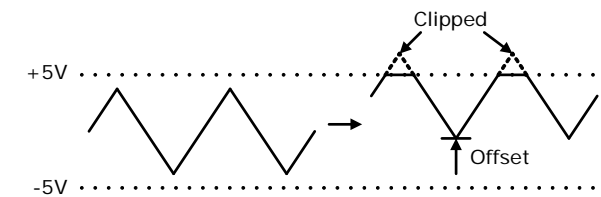

**Negative peak clip (50Ω)**

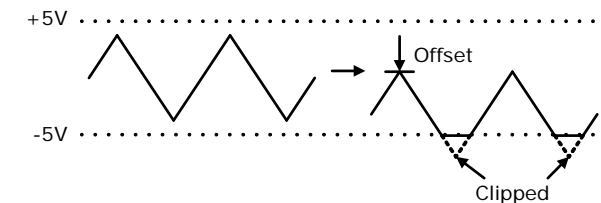



# TTL CMOS OUTPUT





<b>Select waveform</b>	Select the waveform.....	32
<b>Set frequency</b>	Enter frequency.....	32
	Edit frequency.....	33
<b>Set duty cycle</b>	Enter duty cycle.....	33
	Edit duty cycle.....	34
<b>Set amplitude</b>	Set Amplitude .....	34



## Select the waveform

**TTL/CMOS**   Press Shift key, then 9. The TTL sign appears on the display.

**TTL** The TTL/CMOS output is always On when the square wave  is activated.

**TTL/CMOS** Push/pull the TTL/CMOS knob to select the waveform.

  Pushed: TTL is selected as output.





  Pulled: CMOS is selected as output.



**TTL/CMOS OUTPUT** The waveform comes out from the TTL/CMOS terminal.



 TTL:  $\geq 3V_{p-p}$  (fixed)  
CMOS:  $4V \pm 1V_{p-p} \sim 15 \pm 1V_{p-p}$



## Set the Frequency

Enter frequency Enter the waveform frequency using the numerical keys.

    1.2MHz

   37kHz

   45Hz

  Delete a number (backspace)



Edit frequency



Left cursor key moves the active cursor left.

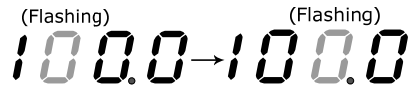

Right cursor key moves the active cursor right.

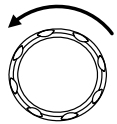
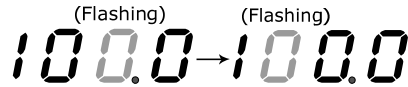

Turn the editing knob left to decrease the frequency.

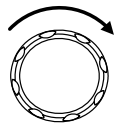
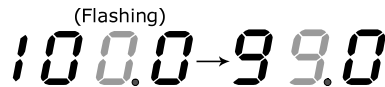

Turn the editing knob right to increase the frequency.

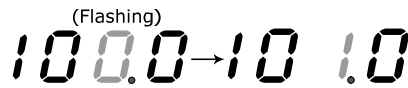

Set the Duty Cycle

Enter duty cycle

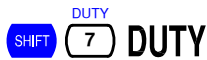

Press the Shift key, then 7 to enter duty cycle editing mode. The duty sign appears on the display.



The default value is 50%.

The settable range is 20% ~ 80%, 2Hz ~ 1MHz.



Use the numerical keys to enter value. Example: 45%



Delete a number (backspace)

Edit duty cycle

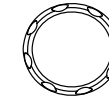

The editing knob changes the value, and the cursor keys moves the active digit (same as entering frequency).



When inactive for 5 seconds, the display automatically goes back to previous mode (frequency view).

Set Amplitude

CMOS waveform



Use the TTL/CMOS knob.



Pushed: selects TTL output with fixed amplitude, min. 3Vp-p.



Pulled: selects CMOS output, amplitude range 4V±1Vp-p ~ 15±0.5Vp-p.

Turn the knob right (increase amplitude) or left (decrease amplitude).

# SWEEP

SFG can add sweep to the waveform output, a convenient tool for measuring the frequency response of the DUT.



- Sweep function applies only to SFG-2100 series.
- Sweep and Modulation (page37) cannot be used together.

## Activate sweep

1. Output the waveform. Sine/Triangle/Square (page25) or TTL/CMOS (page31).
2. Press the Shift key, then 5 (Sweep).



3. Sweep is activated and the sign appears on the display.

**SWEEP**



When the sweep is activated, the duty cycle of Square/TTL/CMOS wave is fixed to 50%.

## Select Log/Lin Sweep

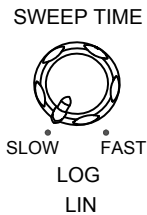

### Logarithmic Sweep:

Pull the SWEEP TIME knob. 

### Linear Sweep:

Push the SWEEP TIME knob. 

## Set Sweep Time

Sweep time sets the time it takes for a single sweep from the start frequency to the end frequency.

Rotate the SWEEP TIME knob, right (fast) or left (slow).



**Range** 1 ~ 30 seconds



Note: If the sweep time becomes too long, the stop frequency might reach the rating (4, 7, 10, or 20MHz). In this case, the frequency stays at the rating to the end.

## Set Sweep Span

Sweep span sets the frequency width of the sweep.

The current output frequency becomes the start frequency.

Rotate the SWEEP SPAN knob, right (wide) or left (narrow).

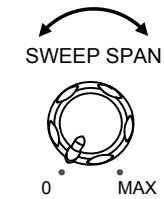

**Range** 1 ~ 100 frequency ratio



Note: In order to get the maximum span (frequency ratio), set the sweep time to a sufficient length (not too short).

# AMPLITUDE MODULATION



- AM applies only to SFG-2100 series.
- Modulation and Sweep (page35) cannot be used together.

## Activate AM

1. Output the waveform, Sine/Triangle/Square (page25).
2. Press the Shift key, then Dot (AM). AM is activated and the sign appears on the display.

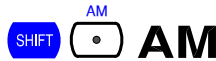

## Set AM depth



1. Pull the SWEEP SPAN knob (AM %).
2. Turn the knob left (shallow) or right (deep).

Range 0 ~ 100%

## Use external modulating signal

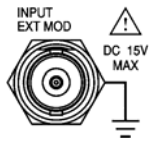

SFG-2000 series uses an internal 400Hz sine wave as the default modulating signal.

1. Connect the modulating signal to the rear panel terminal.
2. Press the Shift key, then 0 (EXT MOD). External modulation is activated.



Frequency Range DC ~ 1MHz

# FREQUENCY MODULATION



- FM applies only to SFG-2100 series.
- Modulation and Sweep (page35) cannot be used together.

## Activate FM

1. Output the waveform. Sine/Triangle/Square (page25) or TTL/CMOS (page31).
2. Press the Shift key, then 4 (FM). FM is activated and the sign appears on the display.



When FM is activated, the duty cycle of Square/TTL/CMOS wave is fixed to 50%.

## Set FM deviation

The output frequency becomes the Center Frequency.

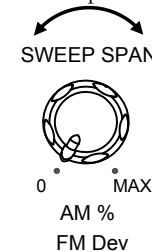

1. Push the SWEEP SPAN knob (FM Dev).
2. Turn the knob left (shallow) or right (deep).

Deviation Range 0 ~ ±50kHz, centered at 1MHz



When the deviation is added to the center frequency, the result must be smaller than the rating frequency.

**Center Frequency + Deviation ≤ Rating (4,7,10,20MHz)**

When this rule is violated, the “Freq-Err3” error message appears and the FM setting will be cancelled.

**FREQ-ERR3**

For more error message details, see page 52.

Center frequency (=Output frequency) must be set within this range.

SFG-2104	300kHz ~ 3.7MHz
SFG-2107	300kHz ~ 6.7MHz
SFG-2110	300kHz ~ 9.7MHz
SFG-2120	300kHz ~ 19.7MHz

Use external modulating signal

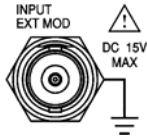

SFG-2000 series uses an internal 400Hz sine wave as the default modulating signal.

1. Connect the modulating signal to the rear panel terminal.
2. Press the Shift key, then 0 (EXT MOD). External modulation is activated.



Frequency	1kHz (fixed)
Range	

# COUNTER INPUT

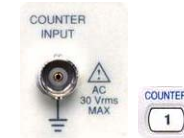

Counter input applies only to SFG-2100 series.

Activate counter

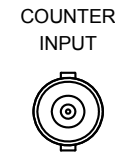

1. Connect the signal input to the Counter input terminal. Press Shift key, then 1 (Counter).



2. EXT and COUNT sign appear on the display.

**EXT COUNT**

3. The display shows the input signal frequency.

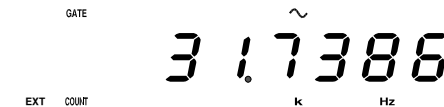

4. The GATE sign flashes when the gate condition is met.

**GATE**

Range 0 ~ 150MHz

Resolution 100nHz for 1Hz input, 0.1Hz for 100MHz input

Set the gate time

Gate time sets the display update rate and counter resolution. These two parameters are in trade-off.  
 Short gate time = faster update, coarse resolution  
 Long gate time = slower update, fine resolution

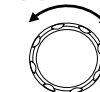

To change the gate time, turn the editing knob right (increase) or left (decrease).

**Gate time / Resolution table**

The following table shows the relationship between counter frequency, gate time, resolution, and display.

Input	Gate time	Resolution	Display
1Hz	0.01s	100μHz	1.0000Hz
	0.1s	10μHz	1.00000Hz
	1s	1μHz	1.000000Hz
	10s	100nHz	1.0000000Hz
10Hz	0.01s	100μHz	10.0000Hz
	0.1s	10μHz	10.00000Hz
	1s	1μHz	10.000000Hz
	10s	100nHz	10.0000000Hz
100Hz	0.01s	1mHz	100.000Hz
	0.1s	100μHz	100.0000Hz
	1s	10μHz	100.00000Hz
	10s	1μHz	100.000000Hz
1kHz	0.01s	10mHz	1.00000kHz
	0.1s	1mHz	1.000000kHz
	1s	100μHz	1.0000000kHz
	10s	10μHz	1.00000000kHz
1MHz	0.01s	10Hz	1.00000MHz
	0.1s	1Hz	1.000000MHz
	1s	100mHz	1.0000000MHz
	10s	10mHz	1.00000000MHz
10MHz	0.01s	100Hz	10.0000MHz
	0.1s	10Hz	10.00000MHz
	1s	1Hz	10.000000MHz
	10s	100mHz	10.0000000MHz
100MHz	0.01s	100Hz	100.0000MHz
	0.1s	10Hz	100.00000MHz
	1s	1Hz	100.000000MHz
	10s	100mHz	00.0000000MHz*

**Over sign**

\* The OVER sign shows that the 100MHz digit contains a real number but hidden from the display. It turns On under the following condition.

- Input frequency: ≥100MHz
- Gate Time: 10s

To view the 100MHz digit, switch to smaller gate time such as 1s or 0.1s.

**OVER**

# STORE/RECALL SETTING



Store the panel setting



Press the Shift key, then 6 to store the current panel setting to internal memories.

Memory range: 0 ~ 9 (10 set)

The “Store 0” sign appears.

Store 0

Enter the memory number, 0 ~ 9. (for example, 1)

Store 1

The “done” sign appears.

done

Recall the panel setting



Press the Shift key, then 3 to recall a panel setting stored in internal memories.

Memory range: 0 ~ 9 (10 set)

The “recall 0” sign appears.

recall 0

Enter the memory number, 0 ~ 9. (for example, 1)

recall 1

The “done” sign appears and the panel setting changes accordingly.

done

Recall the default panel setting



Press the shift key, then 2 to recall the default panel setting.

The “done” message appears.

*done*

The panel is updated with the default setting.

~  
10.0000  
k Hz

Wave type	Sine wave
Frequency	10.0000kHz
TTL/CMOS	Disabled
-20dB	Disabled
Modulation	Disabled
Sweep mode	Disabled

# APPLICATION EXAMPLES

## Reference Signal for PLL System

**Description** The SFG output can be used as a cost-effective reference signal for Phase-Locked-Loop system. Directly connect SFG output to PLL input.

**Block diagram**

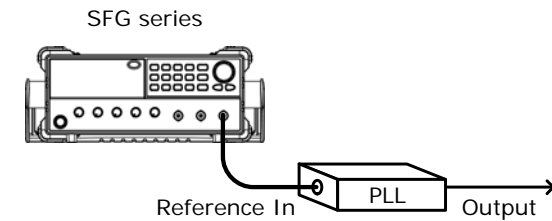

## Trouble-Shooting Signal Source

**Description** The SFG output can be used as the signal source to test the failed part in a circuit system. Isolate the problematic part from the rest, feed the SFG output as a stimulus, and observe the outcome using an oscilloscope.

**Block diagram**

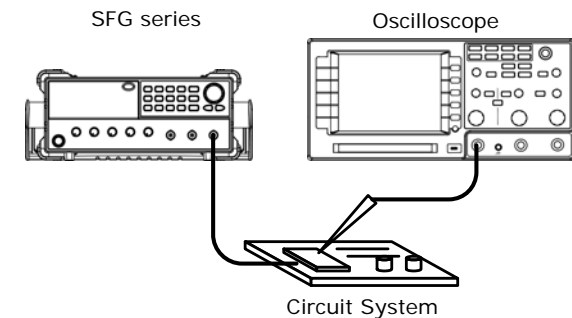

## Transistor DC Bias Characteristics Test

**Description** Use SFG-2000 series as the signal source for a transistor. Compare the transistor input/output waveform using the oscilloscope. Adjust the DC voltage source to find out the maximum output without distorting the waveform.

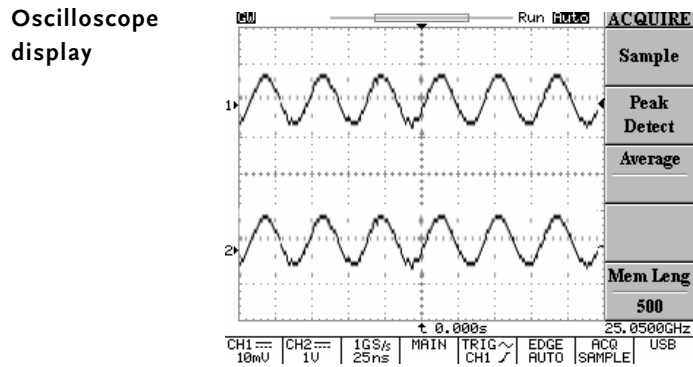
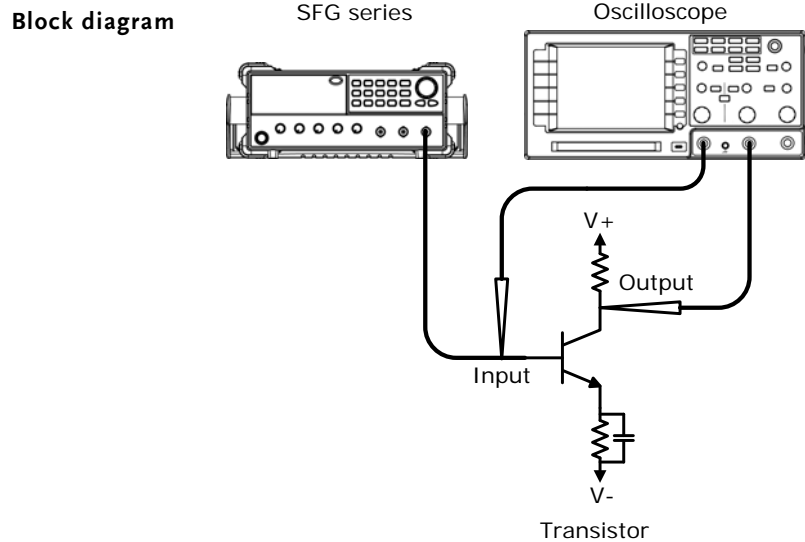

## Amplifier Over-Load Characteristic Test

**Description** Use the triangle wave output from SFG-2000 series to check the amplifier output distortion caused by overload. The common sine wave is not the ideal source in this case. Observe the linearity of the triangle waveform using an oscilloscope.

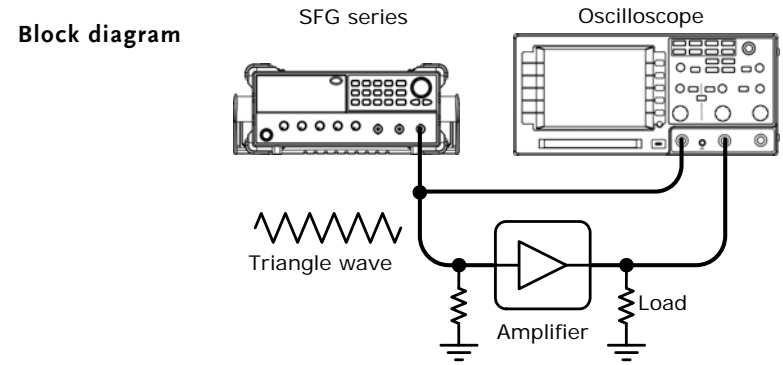

## Amplifier Transient Characteristics Test

**Description** Use the square wave output from SFG-2000 series to check the transient frequency response of an amplifier. The common sine wave is not the ideal source in this case. Observe the waveform using an oscilloscope.

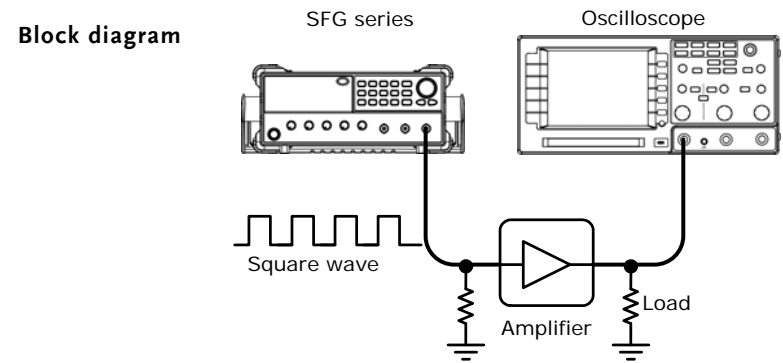

**Test step**

1. Apply a triangle waveform to the amplifier first. Adjust the waveform amplitude to make sure there is no clipping.
2. Switch to square waveform and adjust its frequency to the middle of the amplifier pass band, such as 20Hz, 1kHz, and 10kHz.
3. Observe the shape of the amplifier output. The following table shows the possible output distortions and their explanations.

**Transient characteristic list**

	<ul style="list-style-type: none"> <li>• Amplitude reduction at low frequency</li> <li>• No phase shift</li> </ul>
	<ul style="list-style-type: none"> <li>• Low frequency boosted (accentuated fundamental)</li> </ul>
	<ul style="list-style-type: none"> <li>• High frequency loss</li> <li>• No phase shift</li> </ul>
	<ul style="list-style-type: none"> <li>• Low frequency phase shift</li> <li>• Trace thickened by hum-voltage</li> </ul>
	<ul style="list-style-type: none"> <li>• High frequency loss</li> <li>• Phase shift</li> </ul>
	<ul style="list-style-type: none"> <li>• Low frequency loss</li> <li>• Phase shift</li> </ul>
	<ul style="list-style-type: none"> <li>• Low frequency loss</li> <li>• Low frequency phase shift</li> </ul>
	<ul style="list-style-type: none"> <li>• High frequency loss</li> <li>• Low frequency phase shift</li> </ul>
	<ul style="list-style-type: none"> <li>• Damped oscillation</li> </ul>



**Note**

For narrow band amplifier testing, square wave may not be suitable.

## Logic Circuit Test

**Description**

Use the TTL/CMOS output from SFG-2000 series to test digital circuits. Observe the timing relation of input/output waveform using an oscilloscope.

**Block diagram**

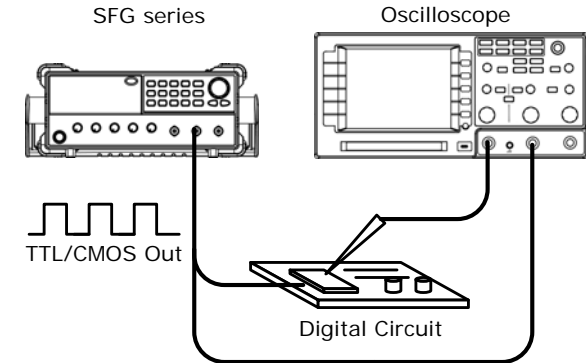

## Impedance Matching Network Test

**Description**

Use SFG-2000 series for impedance matching network: testing its frequency characteristic and matching the impedance.

**Block diagram**

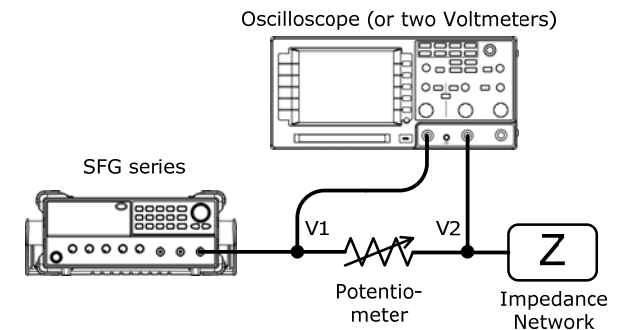

**Test step**

Adjust the potentiometer until V2 becomes the half of V1 ( $V2=0.5V1$ ). Then the impedance Z of the network becomes identical to the potentiometer.



## Speaker Driver Test

**Description** Use SFG-2000 series for testing the frequency characteristics of audio speakers. Record the volt reading versus the input signal frequency.

**Block diagram**

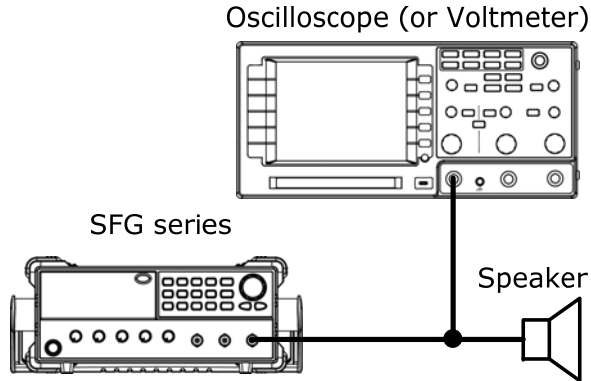

**Graph**

The peak voltage occurs on the resonant frequency of the speaker.

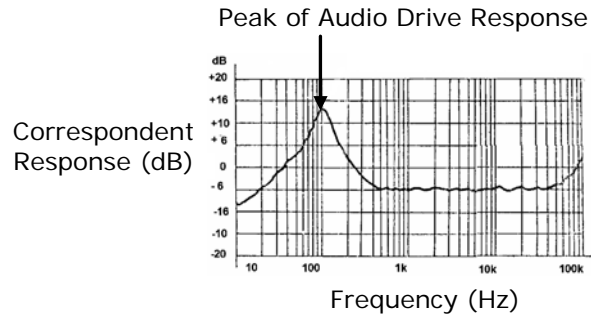

## Sweep for Speaker Test

**Description** Use the sweep feature in SFG-2000 series for testing the frequency response of an audio speaker.

**Test description**

1. Set SFG output to sine wave, 20Hz.
2. Activate sweep and set LIN/LOG, sweep time, and sweep span.
3. Change the frequency if other bands need to be tested.

**Block diagram**

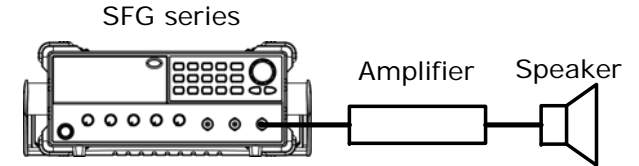

# FAQ

- I pressed the Power key on the front panel but nothing happens.
- How can I get out of Counter/Sweep/Modulation/TTL/-20dB mode?
- The device accuracy does not match the specification.
- What are these error messages?

**I pressed the Power key on the front panel but nothing happens.**

Make sure the AC source voltage setting on the rear panel is correct (page21). Otherwise the internal fuse might be blown out. Contact the service personnel.

**How can I get out of Counter/Sweep/Modulation/TTL/-20dB mode?**

Press the Shift key, then the relevant numerical key. (Do the same action as you entered those modes)

For example: To get out of Counter mode, press Shift then 1.

**The device accuracy does not match the specification.**

Make sure the device is powered On for at least 30 minutes, within +20°C~+30°C. This is necessary to stabilize the unit to match the specification.

**What are these error messages?**

Several messages appear when trying to set the frequency or duty cycle in forbidden way. Page52 summarizes all the error message content.

If there is still a problem, please contact your local dealer or GWInstek at [www.gwinstek.com.tw](http://www.gwinstek.com.tw) / [marketing@goodwill.com.tw](mailto:marketing@goodwill.com.tw).

# APPENDIX

## Error Messages

Frequency error	FrEq-Err	
	FrEq-Err1	Sine and square wave frequency over range. This message appears when entering sine or square waveform frequency larger than the rating. See page26 for sine/square rating.
	FrEq-Err2	Triangle wave Frequency over range. This message appears when entering triangle waveform frequency larger than 1MHz. See page26 for triangle wave rating.
	FrEq-Err3	FM Center Frequency over range. This message appears when trying to enter FM center frequency larger than specified. See page38 for FM center frequency range.

Duty Cycle error	dutY-Err	
	duty-Err1	Not square waveform. This message appears when trying to set duty cycle in non-square (=sine or triangle) waveform. For duty cycle setting, see page28 (square wave) or page33 (TTL/CMOS output).
	duty-Err2	Square wave frequency over range. This message appears when trying to set duty cycle when the square wave frequency is over 1MHz. For square wave frequency setting, see page26.
	duty-Err3	Duty over range. This message appears when the duty cycle setting goes outside 20~80% range. For duty cycle range, see page28 (square wave) or page33 (TTL/CMOS output).

## Specification

Main	Output Function	Sine, Square, Triangle	
	Amplitude Range	10Vp-p (into 50Ω load)	
	Impedance	50Ω ± 10%	
	Attenuator	-20dB ± 1dB x2	
	DC Offset	< -5V ~ >+5V (50Ω load)	
	Duty Range	20% ~ 80%, 2Hz~1MHz (Square Wave)	
	Duty Resolution	1% (Square Wave Only)	
Display	9 digits LED display		
Frequency	Sine/Square Waveform Range	SFG-2004	0.1Hz ~ 4MHz
		SFG-2007	0.1Hz ~ 7MHz
		SFG-2010	0.1Hz ~ 10MHz
		SFG-2020	1Hz ~ 20MHz
		SFG-2104	0.1Hz ~ 4MHz
		SFG-2107	0.1Hz ~ 7MHz
		SFG-2110	0.1Hz ~ 10MHz
	Triangle Waveform Range	SFG-2120	1Hz ~ 20MHz
		Resolution	0.1Hz (1Hz for SFG-2020/2120)
		Stability	±20ppm
		Accuracy	±20ppm
		Aging	±5ppm/year
		Harmonic Distortion	≥ -55dBc, 0.1Hz ~ 200kHz
			≥ -40dBc, 0.2MHz ~ 4MHz
≥ -30dBc, 4MHz ~ 20MHz (Amplitude at maximum position without attenuating 1/10 of any combination setting, TTL/CMOS off)			
Flatness	< ± 0.3dB, 0.1Hz ~ 1MHz		
	< ± 0.5dB, 1MHz ~ 4MHz		
Triangle Wave	Linearity	≥ 98%, 0.1Hz ~ 100kHz ≥ 95%, 100kHz ~ 1MHz	
	Symmetry	±1% of period + 4ns, 0.1Hz ~ 100kHz	
Square Wave	Rise/Fall Time	≤ 25ns at maximum output (50Ω load)	
	Level	4 ± 1Vpp ~ 15 ± 1Vpp, adjustable	
CMOS Output	Rise/Fall Time	≤ 120ns	
	Level	≥ 3Vpp	
TTL Output	Fan Out	20 TTL Load	

Sweep (SFG-2100 Series)	Rise/Fall Time	≤ 25ns	
	Sweep Rate	100:1 Ratio Max, adjustable (Note1)	
	Sweep Time	1 ~ 30s, adjustable (Note2)	
	Sweep Mode	Linear, Logarithmic	
	Amplitude Modulation (SFG-2100 Series)	Depth	0 ~ 100%
		Frequency	400Hz (internal), DC ~ 1MHz (external)
		Carrier BW	100Hz ~ 5MHz (-3dB)
	Frequency Modulation (SFG-2100 Series)	External Modulating	Sensitivity: ≤ 10Vpp for 100% modulation
		Deviation	≥ 0 ~ ±50kHz, center at 1MHz
	Frequency Counter (SFG-2100 Series)	Frequency	400Hz fixed (internal), 1kHz fixed (external)
External Modulating		Sensitivity: ≤ 10Vpp for 10% modulation (center at 1MHz)	
Range		5Hz ~ 150MHz	
Accuracy		Time Base Accuracy ± 1 count	
Store/Recall	Time Base	±20ppm (23±5°C) after 30min warmup	
	Max. Resolution	100nHz for 1Hz, 0.1Hz for 100MHz	
	Input Impedance	1MΩ/150pf	
	Sensitivity	≤ 35mVrms, 5Hz ~ 100MHz ≤ 45mVrms, 100MHz ~ 150MHz	
General	Power Source	AC115V/230V +10%, -15%, 50/60Hz	
	Operation Environment	Indoor Use, Altitude Up to 2000m	
		Ambient Temperature	0 ~ 40°C
		Relative Humidity	≤ 80%, 0 ~ 40°C ≤ 70%, 35 ~ 40°C
	Storage Environment	Install Category II / Pollution Degree 2	
		Temperature:	-10 ~ 70°C
	Humidity:	≤ 70%	
Accessories	Instruction Manual x 1, Power Cord x 1 GTL-101 x 2 (SFG-2100 Series) GTL-101 x 1 (SFG-2000 Series)		
Dimension	107 (W) x 266 (H) x 293 (D)		
Weight	Approx. 3.2kg (SFG-2100 Series)		
	Approx. 3.1kg (SFG-2000 Series)		

Note1: In order to get the maximum sweep span, sweep time needs to be tuned.

Note2: If sweep time is too long, the stop frequency will stay at the maximum frequency until the end of the sweep cycle.

## Declaration of Conformity

We  
**GOOD WILL INSTRUMENT CO., LTD.**  
 (1) No.7-1, Jhongsing Rd., Tucheng City, Taipei County, Taiwan  
 (2) No. 69, Lu San Road, Suzhou City (Xin Qu), Jiangsu Sheng, China  
 declare, that the below mentioned product  
**Type of Product: Synthesized Function Generator**  
**Model Number: SFG-2004, SFG-2007, SFG-2010, SFG-2020,**  
**SFG-2104, SFG-2107, SFG-2110, SFG-2120**  
 are herewith confirmed to comply with the requirements set out in the Council Directive on the Approximation of the Law of Member States relating to Electromagnetic Compatibility (89/336/EEC, 92/31/EEC, 93/68/EEC) and Low Voltage Directive (73/23/EEC, 93/68/EEC). For the evaluation regarding the Electromagnetic Compatibility and Low Voltage Directive, the following standards were applied:

© **EMC**

EN 61326-1: Electrical equipment for measurement, control and laboratory use — EMC requirements (1997 + A1:1998 + A2:2001 + A3:2003)	
Conducted Emission Radiated Emission EN 55011: Class A 1998 + A1:1999 + A2:2002	Electrostatic Discharge EN 61000-4-2: 1995 + A1:1998 + A2:2001
Current Harmonics EN 61000-3-2: 2000 + A2:2005	Radiated Immunity EN 61000-4-3: 2002 + A1:2002
Voltage Fluctuations EN 61000-3-3: 1995 + A1:2001	Electrical Fast Transients EN 61000-4-4: 2004
-----	Surge Immunity EN 61000-4-5: 1995 + A1:2001
-----	Conducted Susceptibility EN 61000-4-6: 1996 + A1:2001
-----	Power Frequency Magnetic Field EN 61000-4-8: 1993 + A1:2001
-----	Voltage Dip/ Interruption EN 61000-4-11: 2004

© **Safety**

Low Voltage Equipment Directive 73/23/EEC & amended by 93/68/EEC
Safety Requirements IEC/EN 61010-1: 2001

## INDEX

<i>2</i>	setup .....	28
20dB attenuation.....	duty cycle error.....	28, 52
example setting .....	faq .....	51
<b>A</b>	<b>E</b>	
AM	EN 61010 .....	6, 7, 55
example setting .....	EN55011.....	55
setup .....	EN61000 .....	55
amplifier application example .....	external modulation .....	37, 39
application examples.....	example setting .....	23
<b>C</b>	<b>F</b>	
cleaning.....	FAQ .....	51
CMOS	FM	
activation.....	example setting .....	23
example setting .....	seup.....	38
constant current circuit.....	frequency	
control knob overview .....	editing .....	27
counter gate time.....	entering.....	26
counter input .....	frequency error .....	27, 39, 52
example setting .....	faq .....	51
<b>D</b>	front panel diagram	
DDS block diagram .....	SFG-2000 .....	13
default panel setting	SFG-2100 .....	13
contents .....	fuse	
recall.....	safety instruction.....	6
default setting	<b>I</b>	
contents .....	impedance application example.....	48
default setting recall .....	in/out terminal overview .....	16
direct digital synthesis .....	<b>L</b>	
display contents overview .....	lin sweep selection.....	35
duty cycle	log sweep selection.....	35
example setting .....	logic application example .....	48

<b>M</b>	
main feature list .....	12
memory recall	
example setting .....	24
memory store	
example setting .....	24
model lineup .....	12
<b>N</b>	
numerical keys overview .....	15
<b>O</b>	
offset .....	30
example setting .....	22
operation environment	
safety instruction .....	7
operation shortcuts .....	22
<b>P</b>	
phase locked loop	
example application .....	44
power supply	
safety instruction .....	6
power up sequence .....	21
FAQ .....	51
<b>R</b>	
rear panel .....	19
recall setting .....	42
<b>S</b>	
safety	
guidelines .....	6
symbol .....	5
UK power cord .....	8
setup step .....	20
sine wave	
example setting .....	22
selection .....	26
speaker application example .....	49, 50
specification .....	53
FAQ .....	51
square wave	
duty cycle .....	28
example setting .....	22
selection .....	26
storage environment	
safety instruction .....	7
store setting .....	42
sweep	
example setting .....	23
setup .....	35
<b>T</b>	
table of contents .....	3
technical background .....	10
tilt stand .....	20
transistor application example .....	45
triangle wave	
example setting .....	22
selection .....	26
troubleshooting application example .....	44
TTL	
activation .....	32
example setting .....	22